

BinaxNOW™
COVID-19 Ag CARD HOME TEST KIT
PROCEDURE CARD

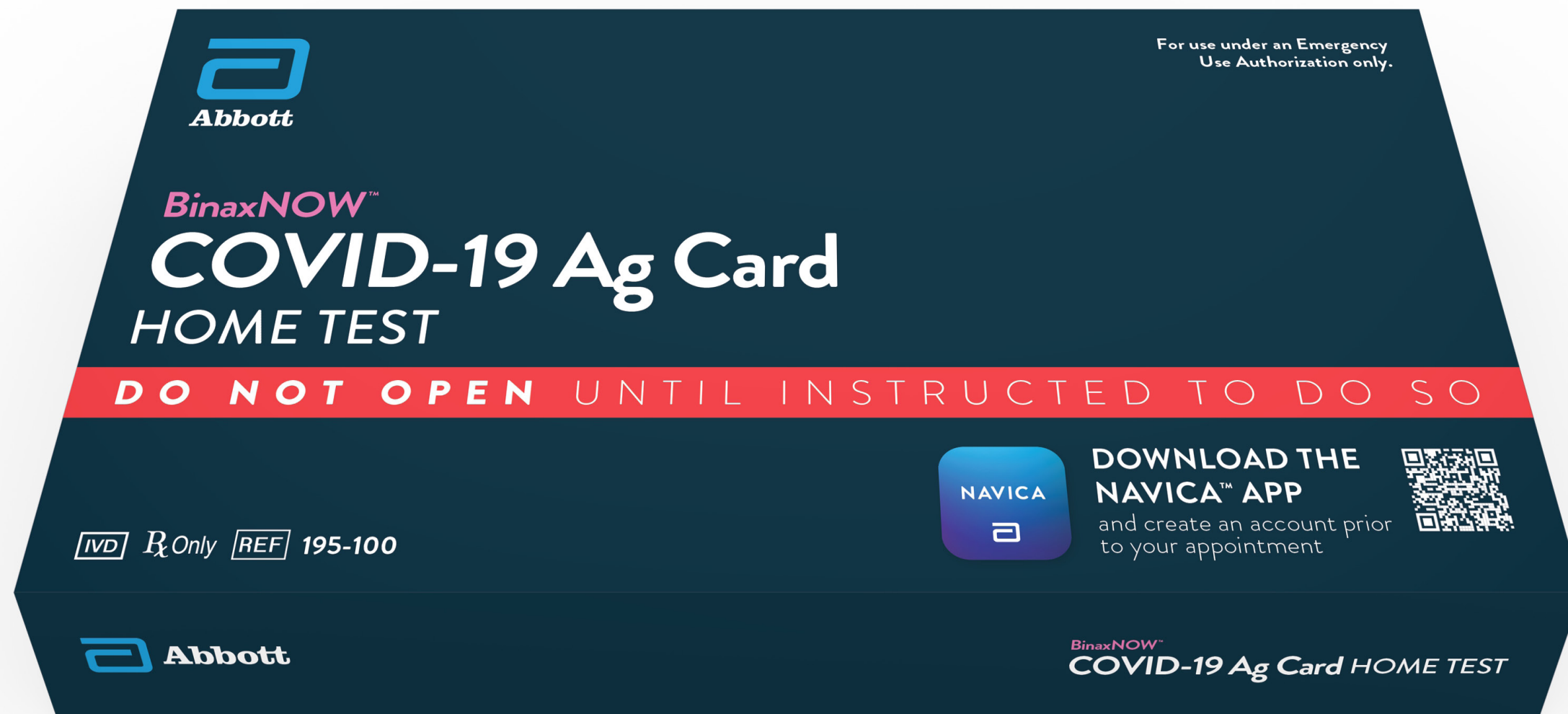

DO NOT OPEN ITEMS UNTIL INSTRUCTED TO DO SO

The BinaxNOW™ COVID-19 Ag Card Home Test is for FDA Emergency Use Authorization (EUA) Only

For Prescription Use Only
For *In Vitro* Diagnostic (IVD) Use

- This product has not been FDA cleared or approved but has been authorized by FDA under an EUA.
- This product has been authorized only for the detection of proteins from SARS-CoV-2, not for any other viruses or pathogens.
- This product is only authorized for the duration of the declaration that circumstances exist justifying the authorization of emergency use of IVDs for detection and/or diagnosis of COVID-19 under Section 564(b)(1) of the Federal Food, Drug and Cosmetic Act, 21 U.S.C. § 360bbb-3(b)(1), unless the declaration is terminated or authorization is revoked sooner.
- For more information on EUAs go here: <https://www.fda.gov/emergency-preparedness-and-response/mcm-legal-regulatory-and-policy-framework/emergency-use-authorization>
- For the most up to date information on COVID-19, please visit: www.cdc.gov/COVID19
- For detailed instructions, please visit: BinaxNOWhometest.abbott.com

Frequently Asked Questions

Will this test hurt?

No, the nasal swab is not sharp and it should not hurt. Sometimes the swab can feel slightly uncomfortable or tickly. If you feel pain, please stop the test and seek advice from a healthcare provider.

What are the known and potential risks and benefits of this test?

Potential risks include:

- Possible discomfort during sample collection.
- Possible incorrect test results (see Results section).

Potential benefits include:

- The results, along with other information, can help your healthcare provider make informed recommendations about your care.
- The results of this test may help limit the spread of COVID-19 to your family and others in your community.

You have the option to refuse this test. However, your doctor has prescribed this test because they believe it could help with your care.

Hazardous Ingredients for the Reagent Solution

Chemical Name/CAS	GHS Code for each Ingredient	Concentration
Sodium Azide/26628-22-8	Acute Tox. 2 (Oral), H300 Acute Tox. 1 (Dermal), H310	0.0125%

The solution in the tube contains a hazardous ingredient (see table above). **If the solution contacts the skin or eye, flush with**

plenty of water. If irritation persists, seek medical advice.

<http://www.poison.org/contact-us> or 1-800-222-1222.

What is the difference between an antigen and molecular test?

There are different kinds of tests for COVID-19. Molecular tests (also known as PCR tests) detect genetic material from the virus. Antigen tests detect proteins from the virus. Antigen tests are very specific for the virus, but are not as sensitive as molecular tests. This means that a positive result is highly accurate, but a negative result does not rule out infection. If your test result is negative, you should discuss with your healthcare provider whether an additional molecular test would help with your care, and when you should discontinue home isolation.

How Accurate is this Test?

Based on the interim results of a clinical study where the BinaxNOW™ COVID-19 Ag Card Home Test was compared to an FDA authorized high sensitivity SARS-CoV-2 test, BinaxNOW COVID-19 Ag Card Home Test correctly identified 91.7% of positive specimens and 100% of negative specimens.

Frequently Asked Questions

Due to the relatively small sample size for the home use clinical study, the BinaxNOW COVID-19 Ag Card Home Test is estimated to correctly identify between 73.0% and 98.9% of positive specimens as reflected in the 95% Confidence Interval. This is consistent with the performance established in a separate multi-site clinical study in the US, where the BinaxNOW COVID-19 Ag Card test was performed and results interpreted by test operators with no laboratory experience. In that study, BinaxNOW COVID-19 Ag Card test correctly identified 84.6% of positive specimens and 98.5% of negative specimens.

Based on this information, negative results may require additional testing to confirm your result. Please talk to your healthcare provider to determine if you need additional testing.

Indication

The BinaxNOW COVID-19 Ag Card Home Test is a lateral flow immunoassay intended for the qualitative detection of nucleocapsid protein antigen from SARS-CoV-2. This test is authorized for prescription home use with self-collected observed direct anterior nasal (nares) swab samples from individuals aged 15 years or older who are suspected of COVID-19 by their healthcare provider within the first seven days of symptom onset or adult collected nasal swab samples from individuals aged four years or older who are suspected of COVID-19 by their healthcare provider within the first seven days of symptom onset. The BinaxNOW COVID-19 Ag Card Home Test is to be performed only with the supervision of a telehealth proctor.

The BinaxNOW COVID-19 Ag Card Home Test does not differentiate between SARS-CoV and SARS-CoV-2.

Results are for the identification of SARS-CoV-2 nucleocapsid protein antigen. Antigen is generally detectable in anterior nasal (nares) swabs during the acute phase of infection. Positive results indicate the presence of viral antigens, but clinical correlation with patient history and other diagnostic information is necessary to determine infection status. Positive results do not rule out bacterial infection or co-infection with other viruses. The agent detected may not be the definite cause of disease.

Negative results should be treated as presumptive and confirmation with a molecular assay, if necessary, for patient management, may be performed. Negative results do not rule out SARS-CoV-2 infection and should not be used as the sole basis for treatment or patient management decisions including infection control decisions. Negative results should be considered in the context of a patient's recent exposures, history and the presence of clinical signs and symptoms consistent with COVID-19.

Individuals who test negative and continue to experience COVID-like symptoms should seek follow up care from their healthcare provider.

BinaxNOW COVID-19 Ag Card Home Test is only for use under the Food and Drug Administration's Emergency Use Authorization.

All prescribing healthcare providers will report all test results they receive from individuals who use the authorized product to relevant public health authorities in accordance with local, state, and federal requirements using appropriate LOINC and SNOMED codes, as defined by the Laboratory *In Vitro* Diagnostics (LIVD) Test Code Mapping for SARS-CoV-2 Tests provided by CDC.

Wash Your Hands

Wash or sanitize your hands. Make sure they are dry before starting.

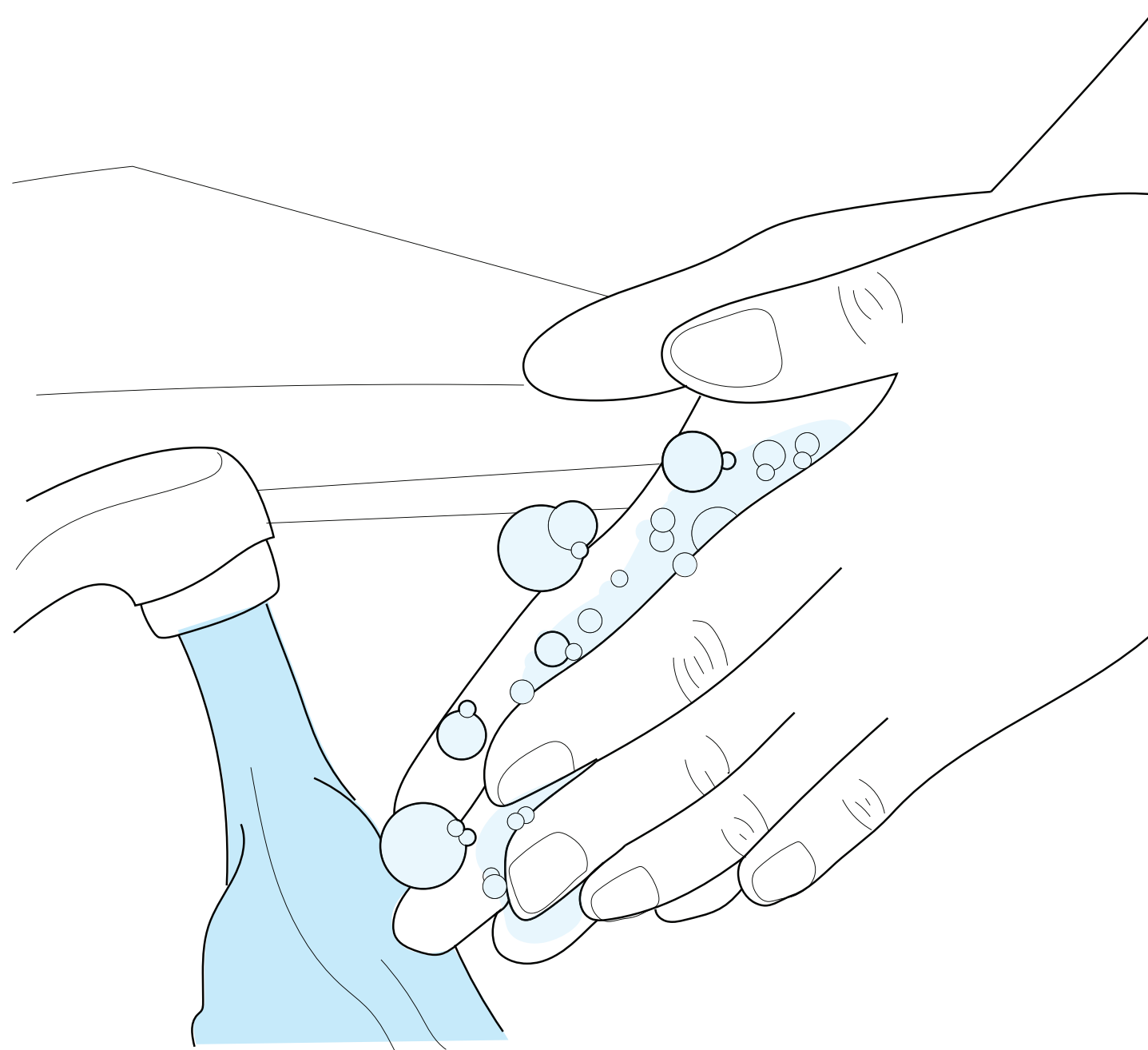

1 Set Up

It is recommended gloves (not provided) also be used during testing.



DO NOT open items until instructed.

Open your test kit. You should have:

1 Swab

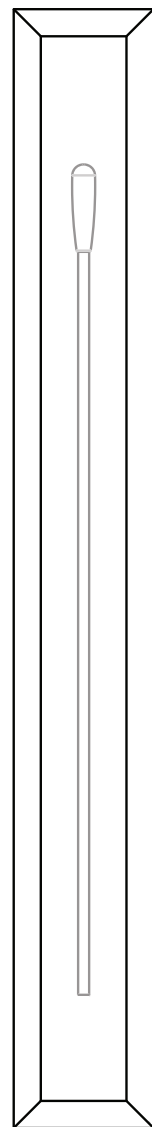

1 Test Card

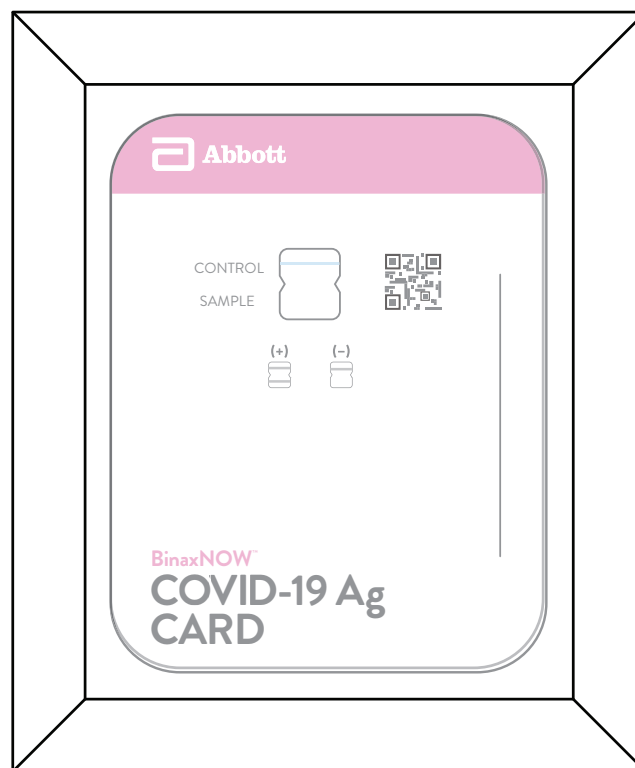

1 Bottle



or



2 Open Pouch and Scan QR Code on Card

If using a mobile device:



If using a computer:

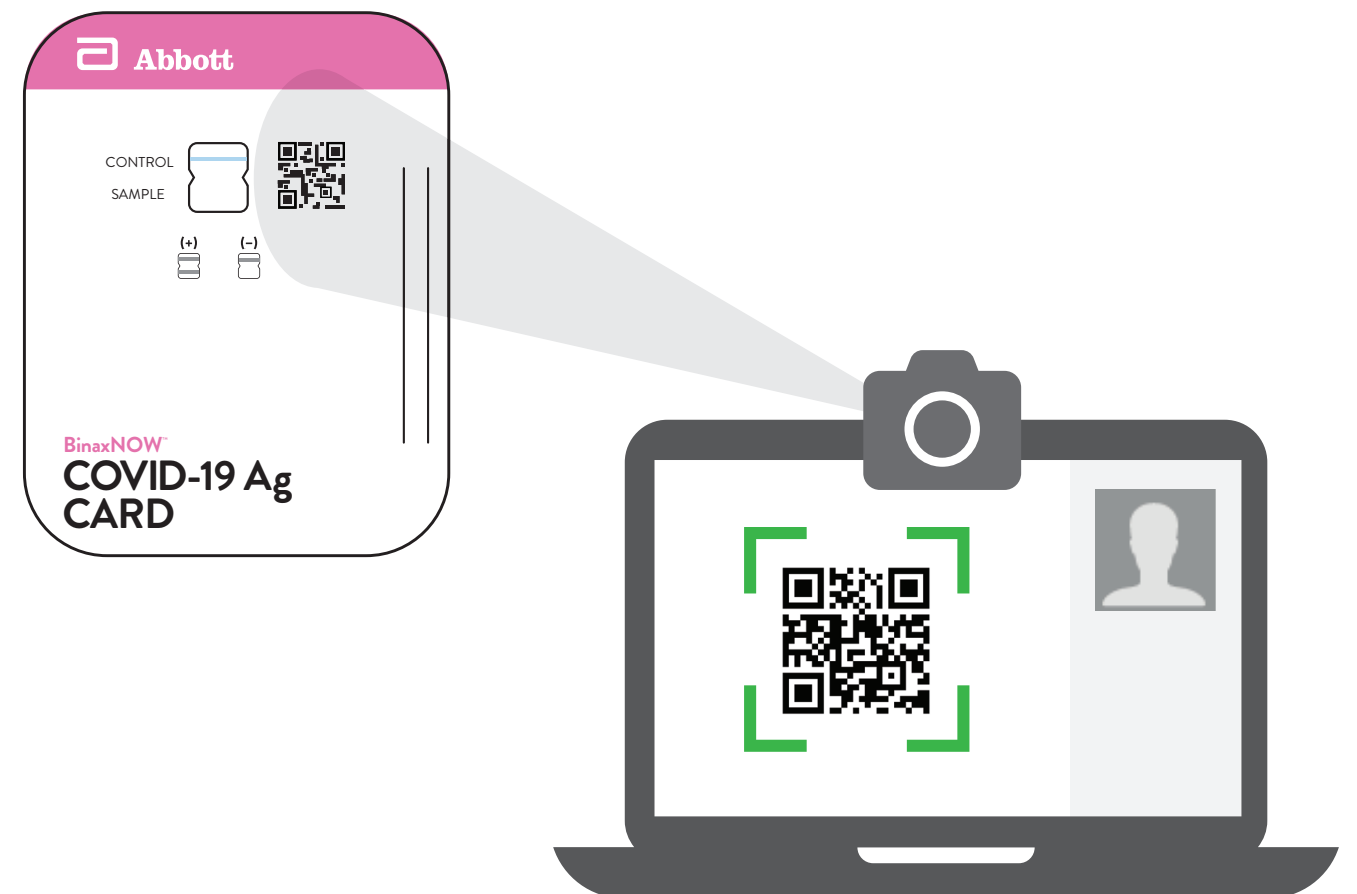

3 Open Card



Card must stay FLAT on table for entire test.

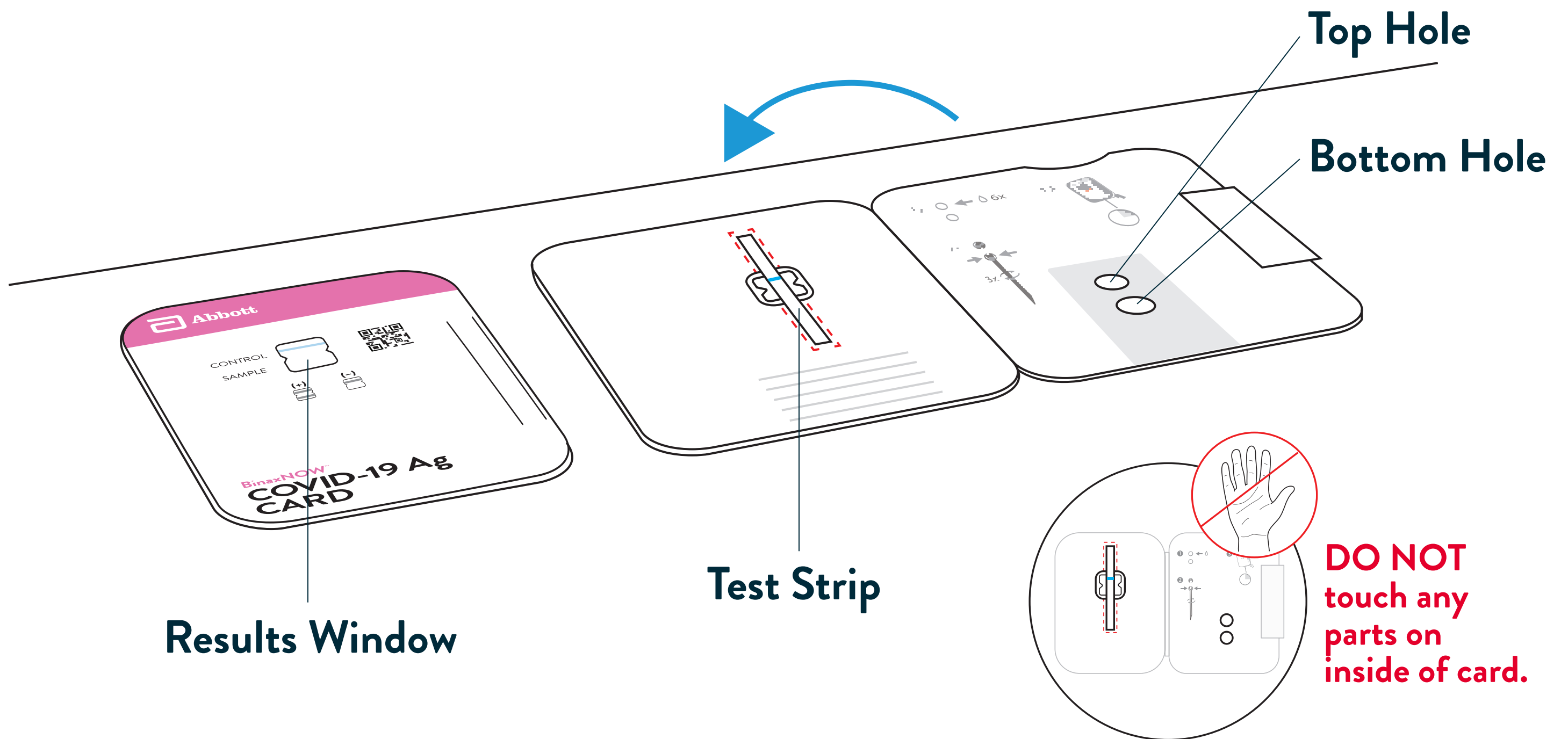

4 Apply Fluid to Top Hole

A. Remove dropper bottle cap.

B. Hold dropper bottle straight over TOP HOLE, not at an angle.

C. Put 6 DROPS into TOP HOLE. Do not touch card with tip.



Note: False negative results may occur if less than 6 drops of fluid is used.

5 Open Swab



Keep fingers away from swab end.

A. Open swab package at stick end.

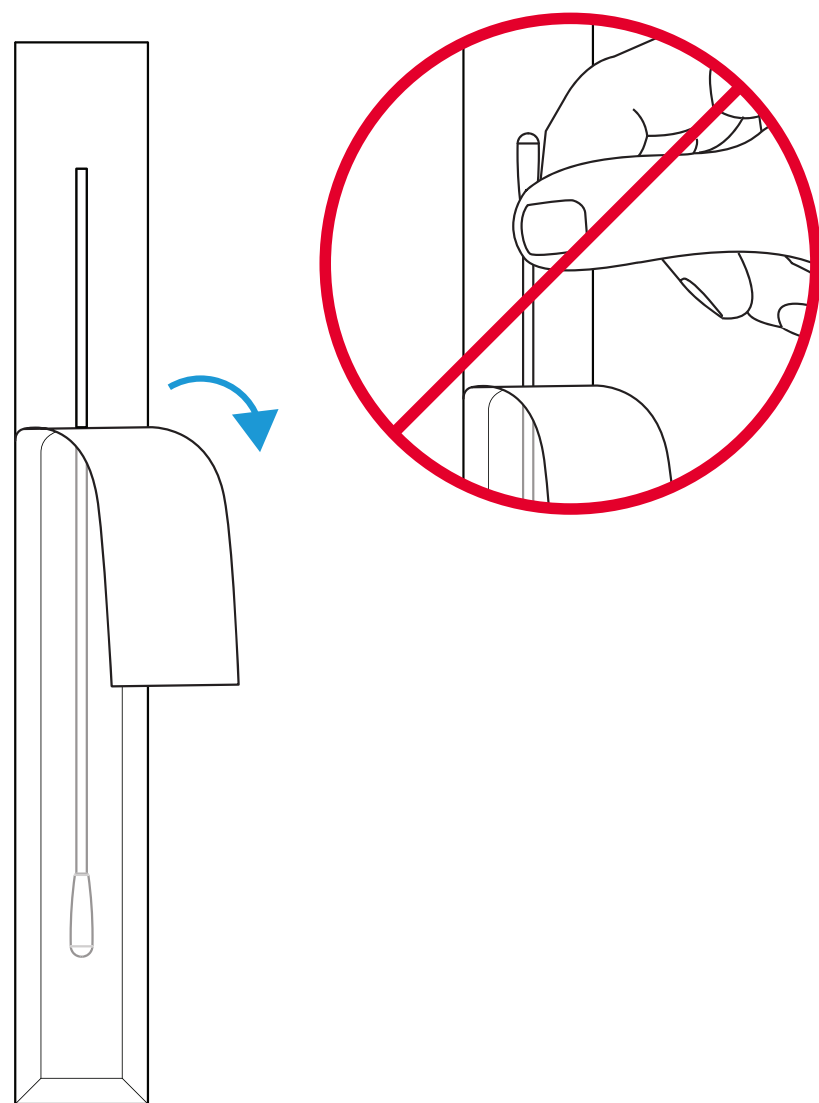

B. Take swab out.

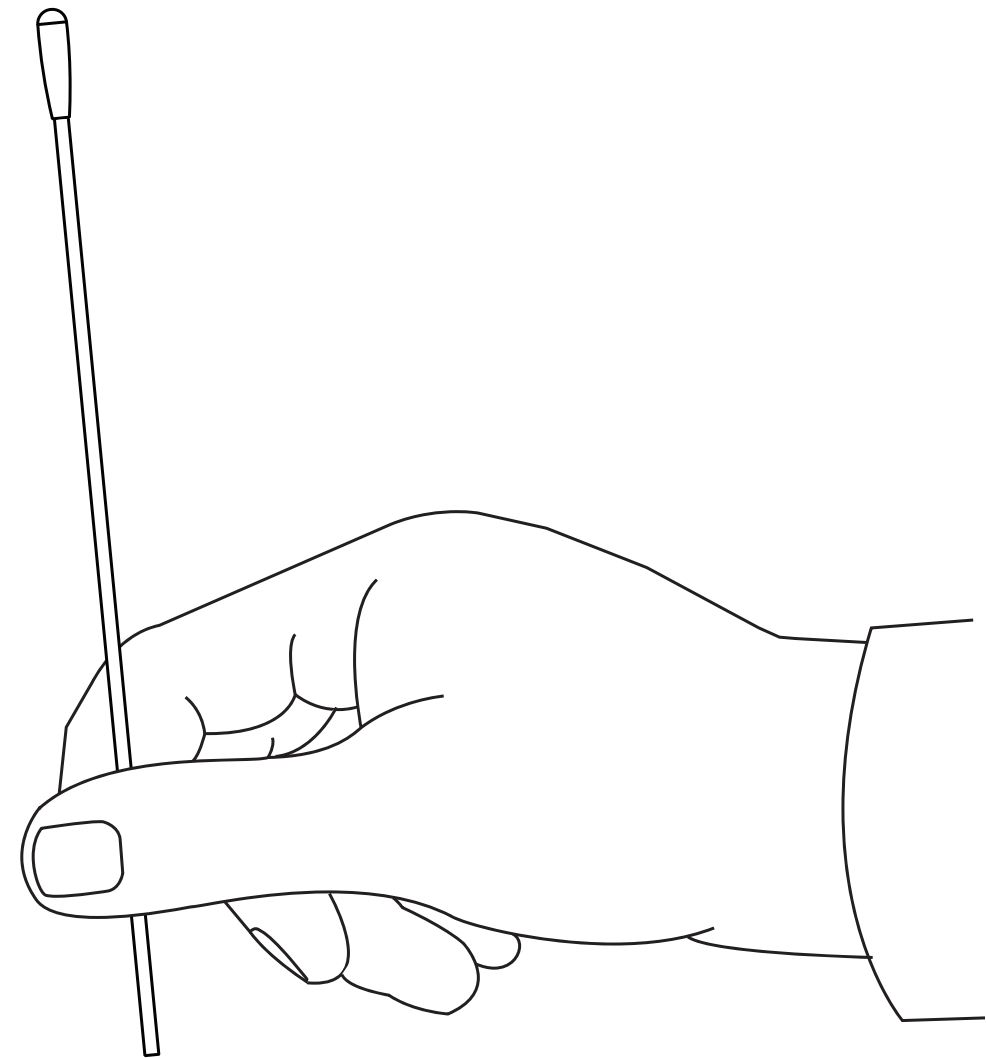

6 Swab Left Nostril

A. Insert the entire absorbent tip of the swab (usually 1/2 to 3/4 of an inch) into left nostril.

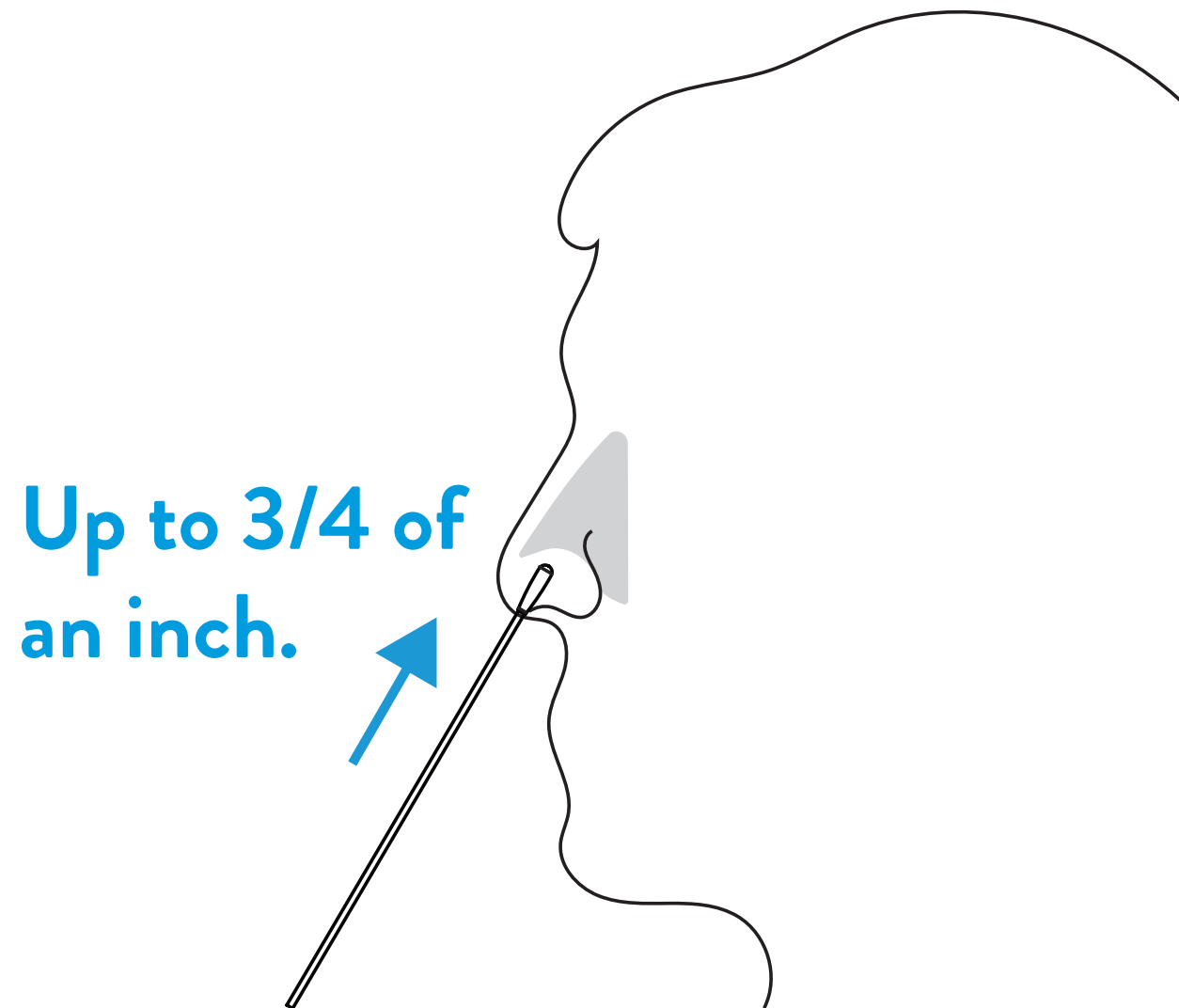

B. Firmly brush against insides of nostril in a circular motion 5 times or more for at least 15 seconds.

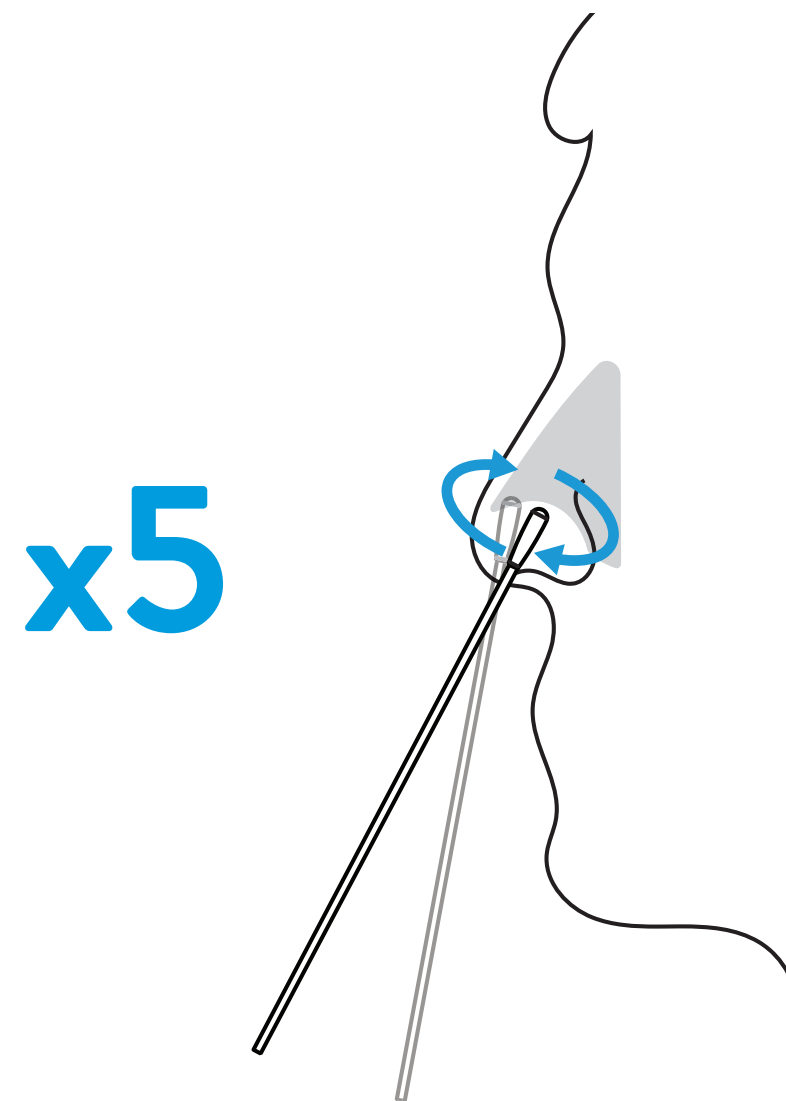

7 Swab Right Nostril

A. Remove swab and insert it into right nostril.

B. Firmly brush against insides of nostril in a circular motion 5 times or more for at least 15 seconds.

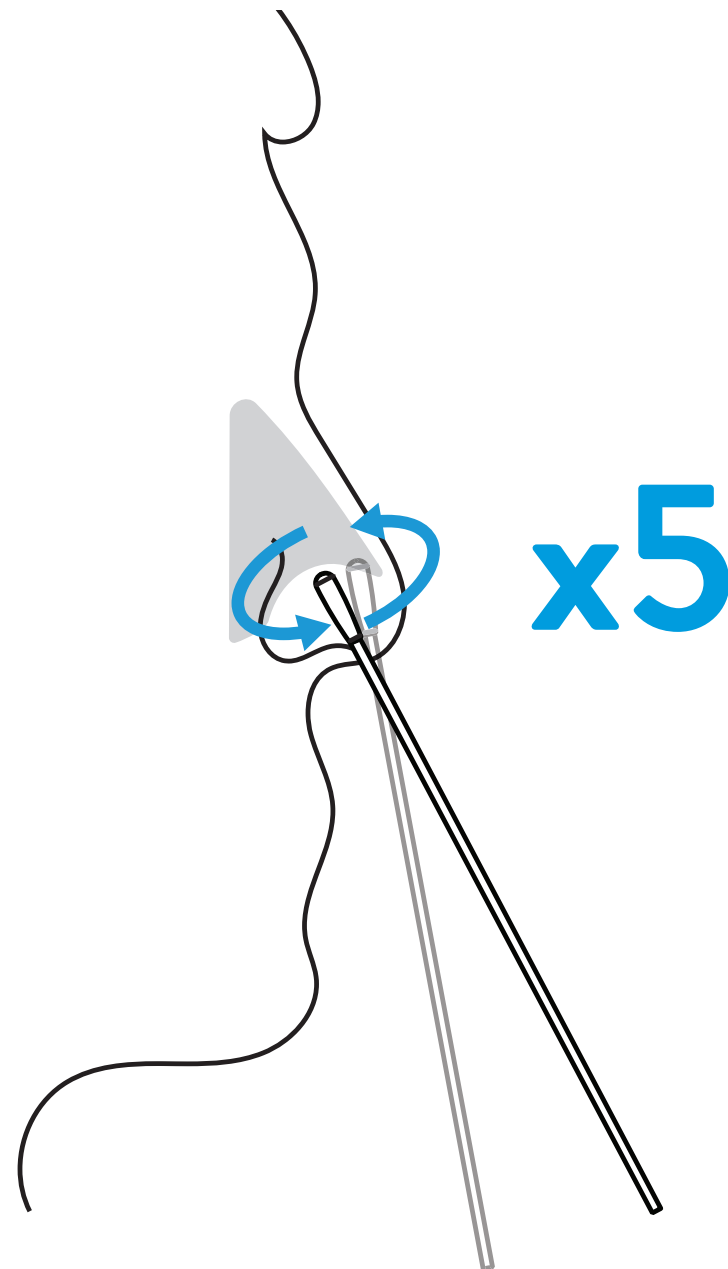

Note: False negative results may occur if the nasal swab is not properly collected.

8 Insert Swab into Bottom Hole



Keep card **FLAT** on table.

Insert swab tip into **BOTTOM HOLE** and firmly push up until tip fills **TOP HOLE**.

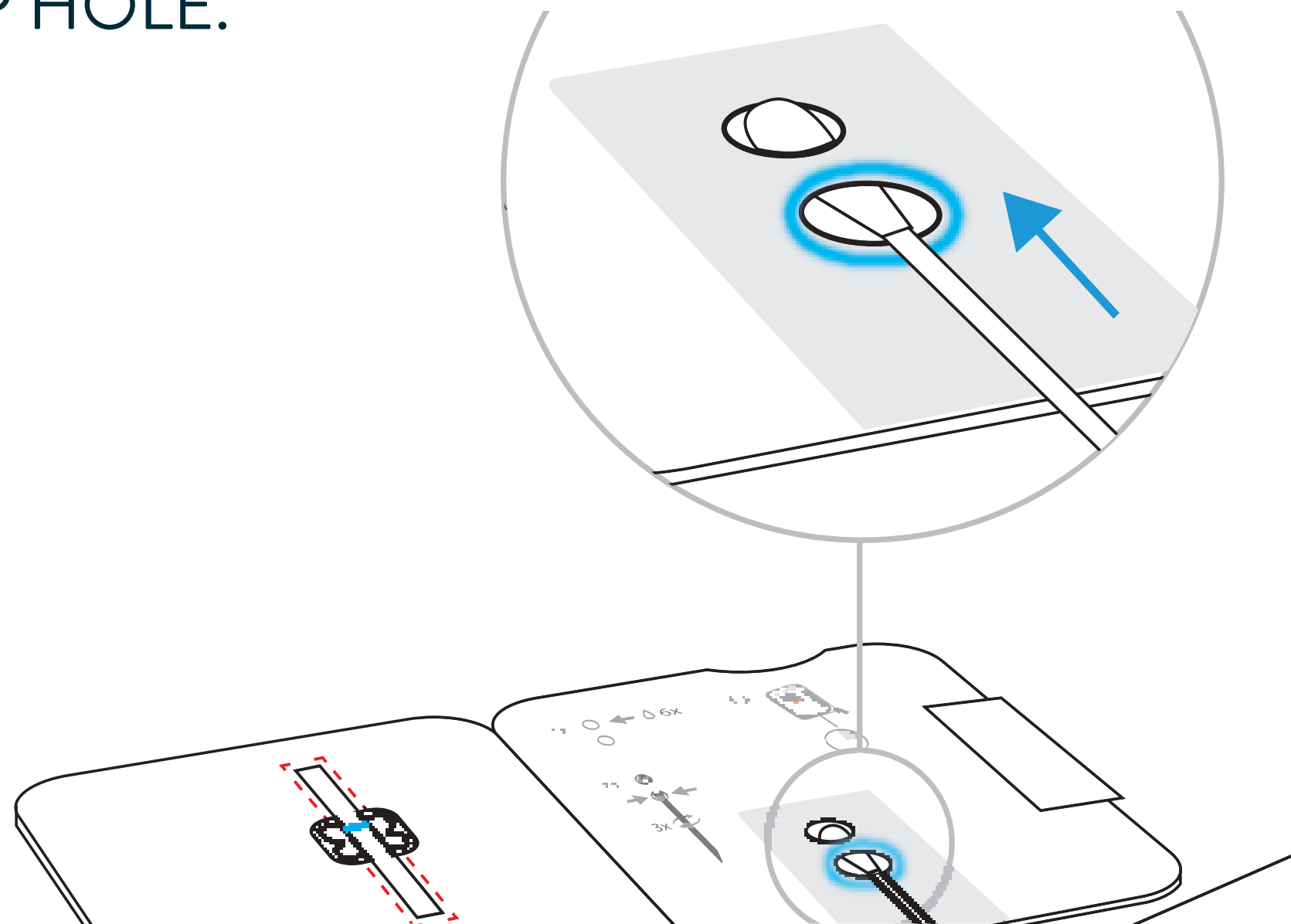

9 Turn Swab 3 Times



Keep card **FLAT** on table.

Turn swab to right 3 times in card and leave it in place.

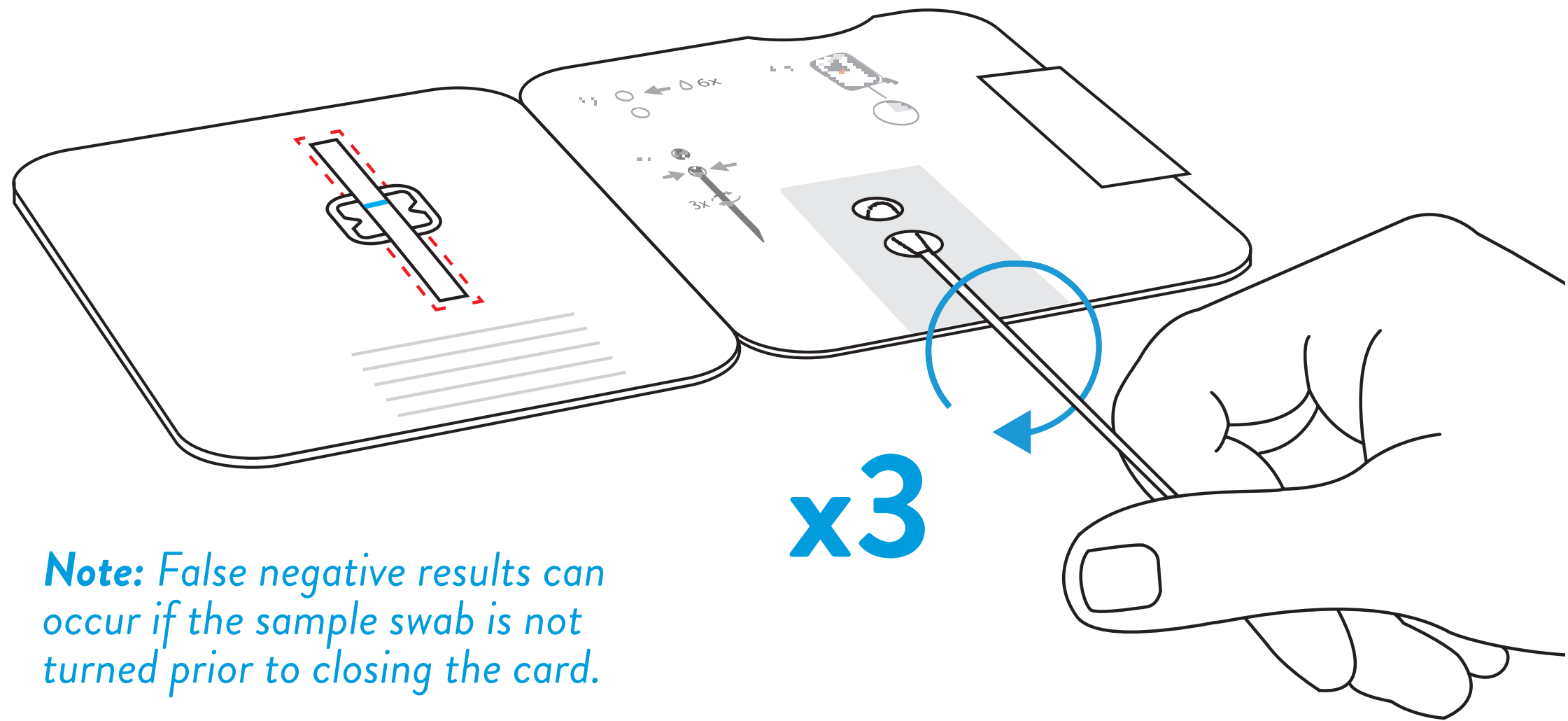

Note: False negative results can occur if the sample swab is not turned prior to closing the card.

10 Peel Strip



DO NOT remove swab.



Keep card FLAT on table.

Keep swab in place. Peel adhesive liner off.

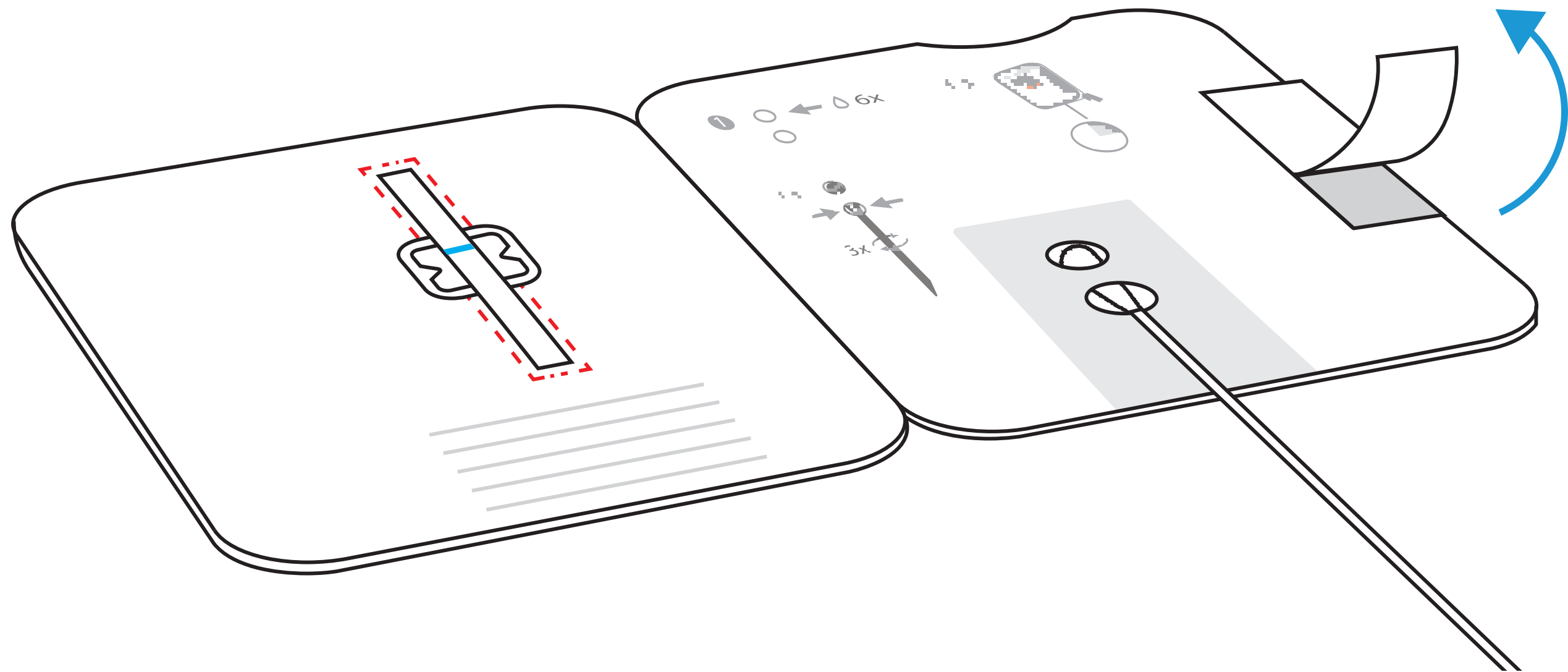

11 Close Card and Seal



DO NOT remove swab.



Keep card FLAT on table.

Close left side of card over swab to seal it. Keep card face up on table.

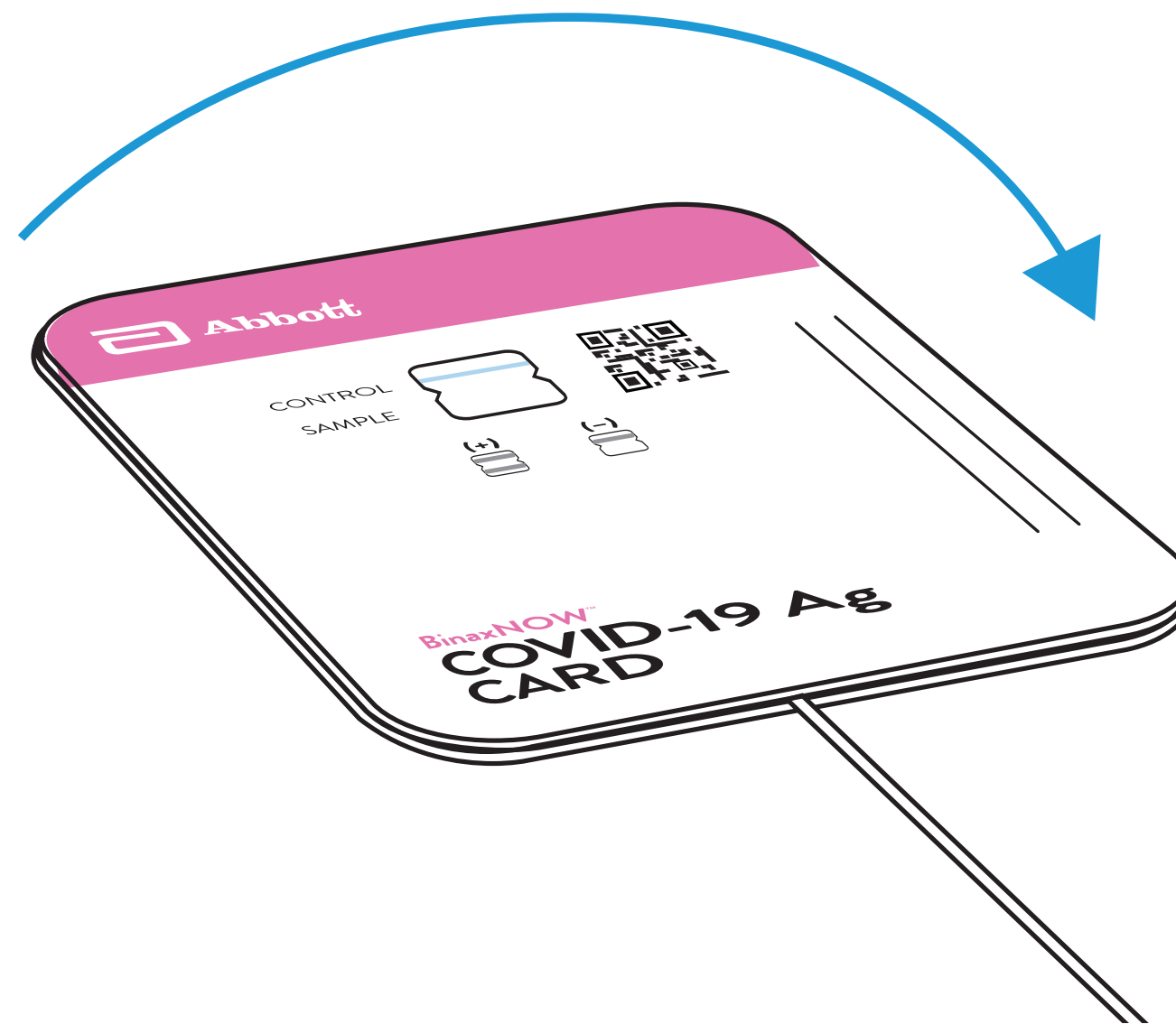

12 Wait 15 Minutes



DO NOT disturb card during this time.

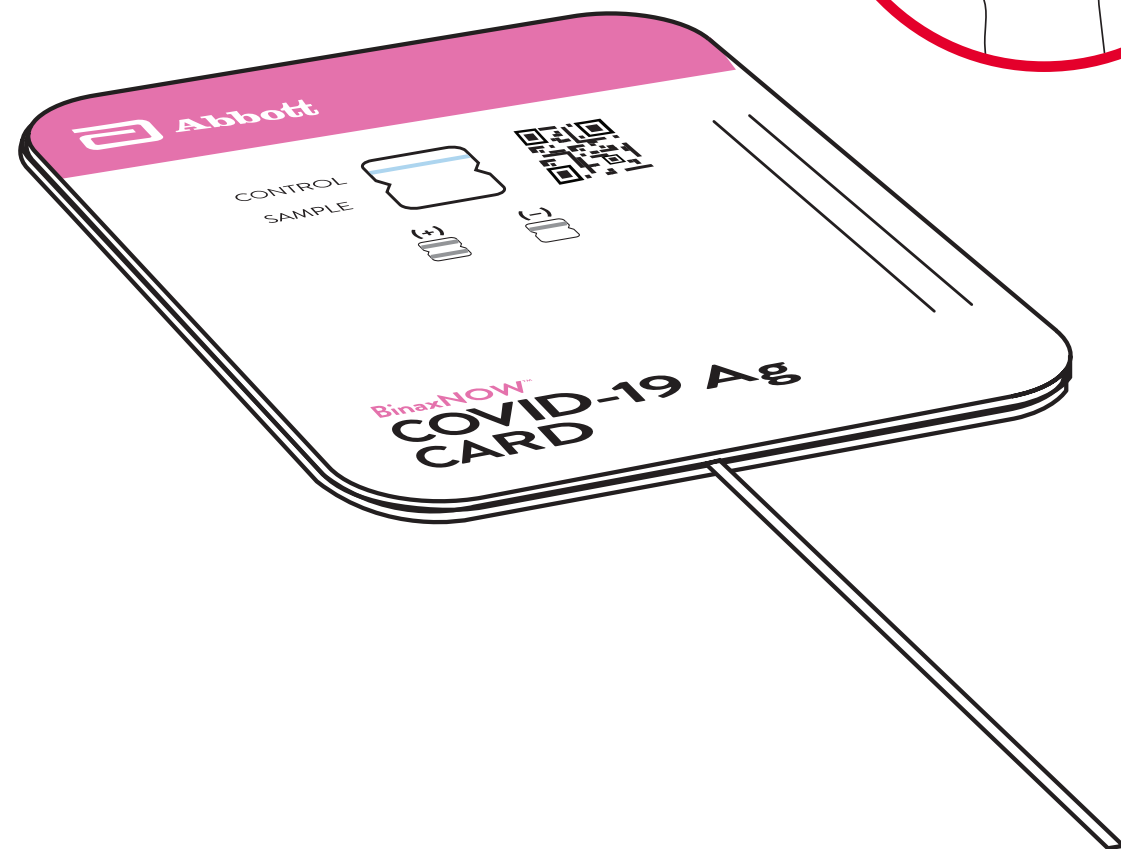

15:00

Note: False results can occur if the card is disturbed/moved or test results are read before 15 minutes.

13 Scan QR Code

If using a mobile device:



If using a computer:

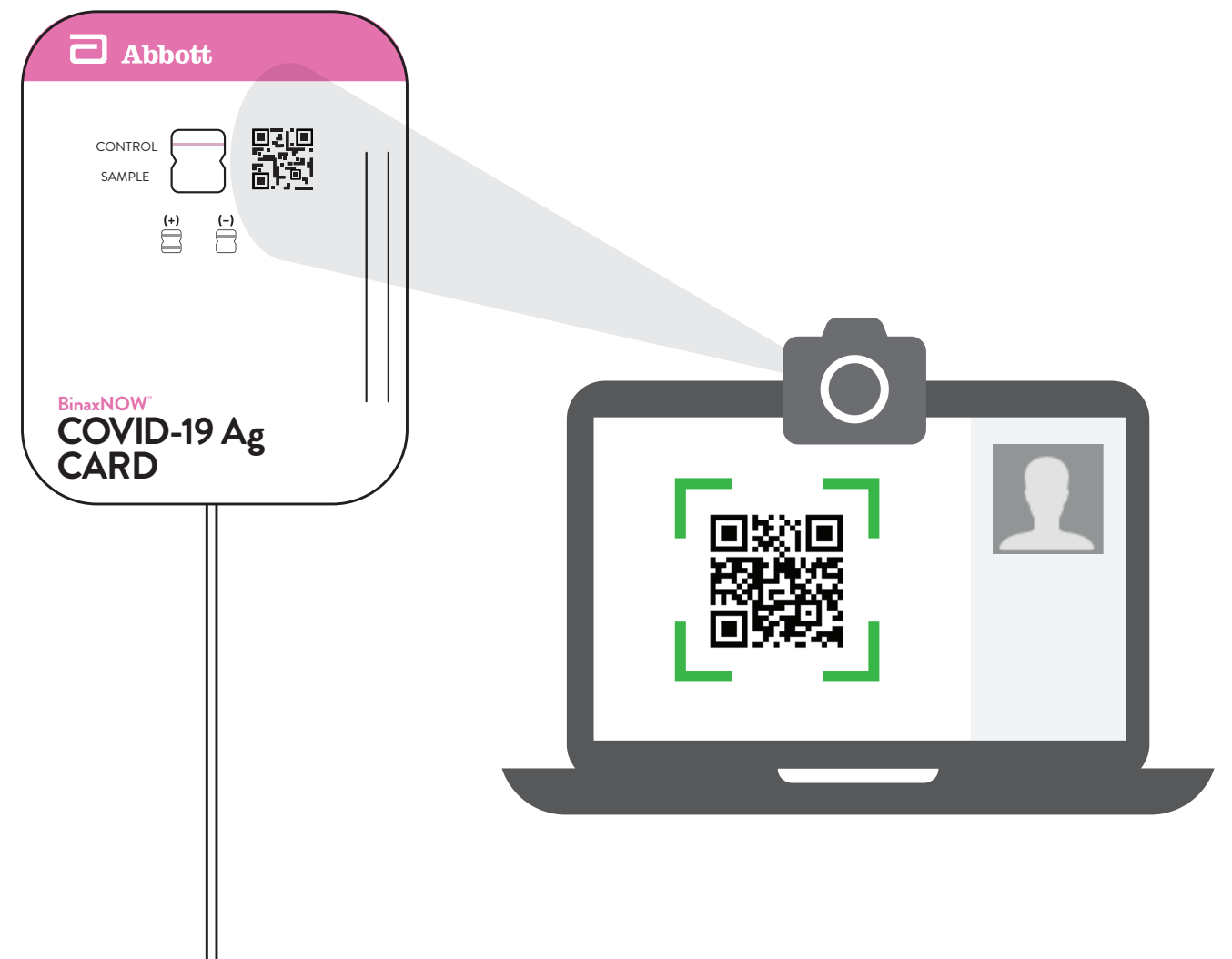

14 Show Result to Your Proctor

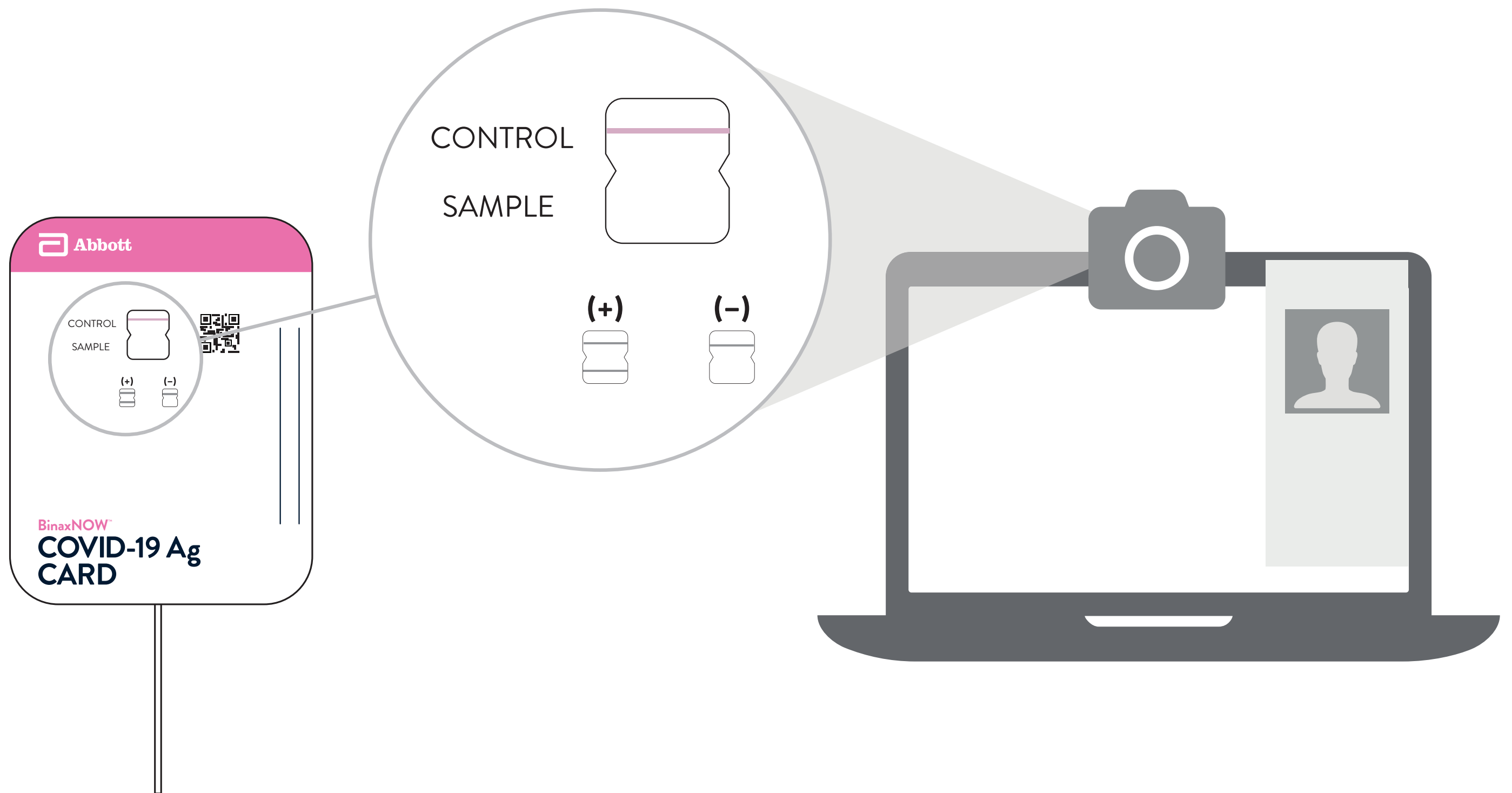

15 Steps to Check Your Results

There are three types of results possible. You will be instructed how to read each type in a specific order. Follow this order with your proctor:

- 1. Check for a Positive Result**
- 2. Check for a Negative Result**
- 3. Check for an Invalid Result**

16 Check for Positive COVID-19 Result

Find result window and look carefully for two pink/purple lines in window.

- **Positive Result:** Two pink/purple lines will appear. One on the top half and one on the bottom half. **COVID-19 was detected.**

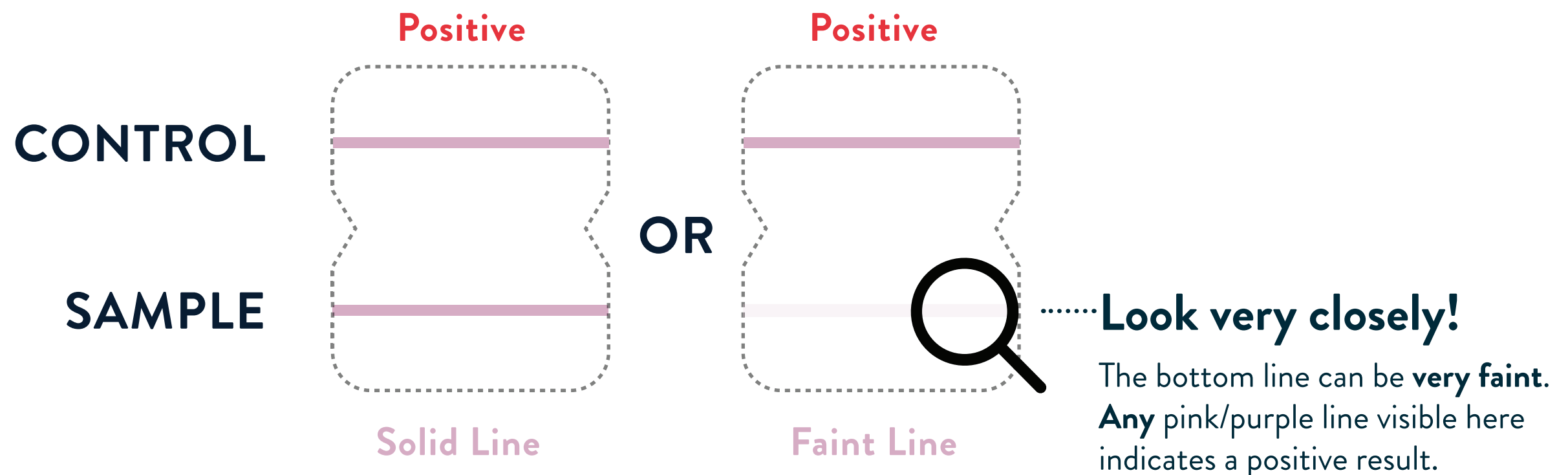

Here are photos of actual positive tests. On the right, note how faint the bottom line can get.



Positive COVID-19 Result

A positive test result means it is very likely you have COVID-19 and it is important to be under the care of your healthcare provider. The telehealth proctor is not a healthcare provider. It is also likely that you may be placed in isolation to avoid spreading the virus to others. There is a very small chance that this test can give a positive result that is wrong (a false positive result). Your healthcare provider will work with you to determine how best to care for you based on your test result(s) along with your medical history, and your symptoms.

17 Check for Negative COVID-19 Result

Find result window and look for a single pink/purple line in window.

- **Negative Result:** A single pink/purple line on the top half where it says “Control.” **COVID-19 was not detected.**

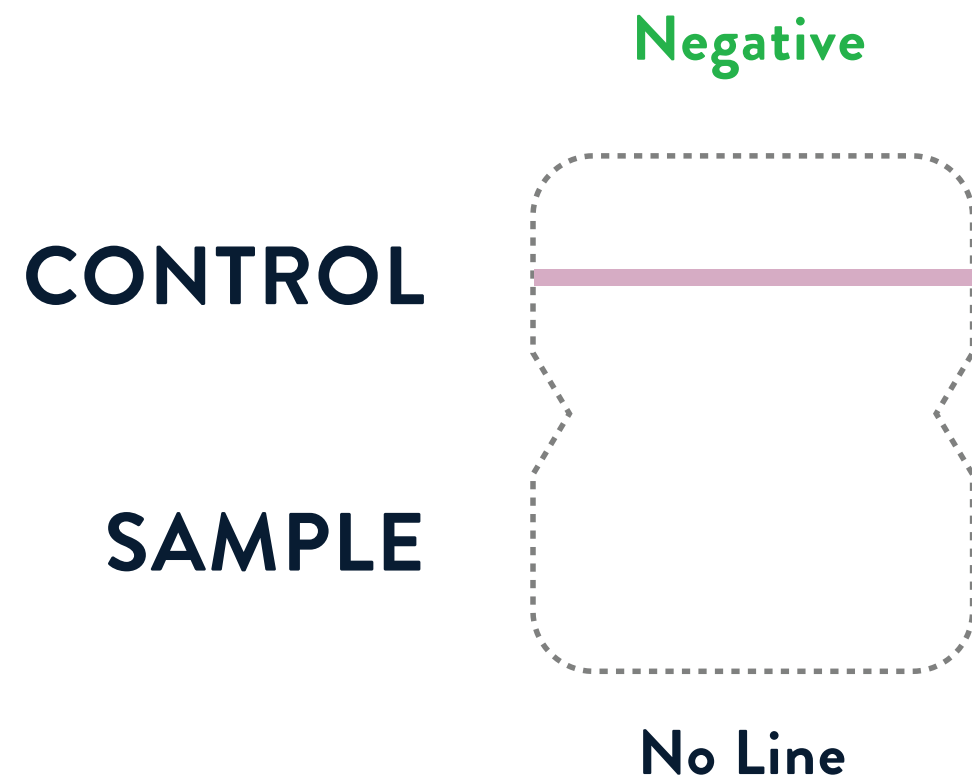

Negative COVID-19 Result

A negative test result means that proteins from the virus that causes COVID-19 were not found in your sample. Negative results may require additional molecular testing to confirm that you do not have COVID-19.

It is possible for this test to give a negative result that is incorrect (false negative) in some people with COVID-19. This means that you could possibly still have COVID-19 even though the test is negative. If your test result is negative, please consult your healthcare provider. The telehealth proctor is not a healthcare provider. Your healthcare provider will consider the test result together with all other aspects of your medical history (such as symptoms, possible exposures, and geographical location of places you have recently traveled) in deciding how to care for you.

If you or the telehealth proctor disagree on the presence of a faint line and/or the presence of a line is uncertain, additional confirmatory testing should be conducted.

It is important that you work with your healthcare provider to help you understand the next steps you should take.

18 Check for Invalid Result

 If you see any of these, the test is invalid.

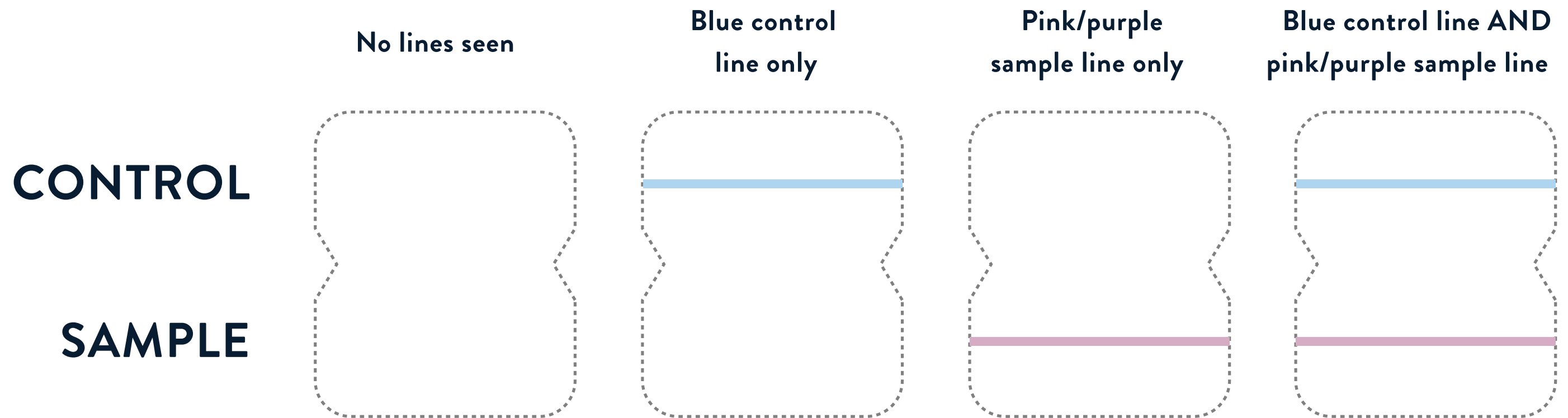

19 Dispose in Trash

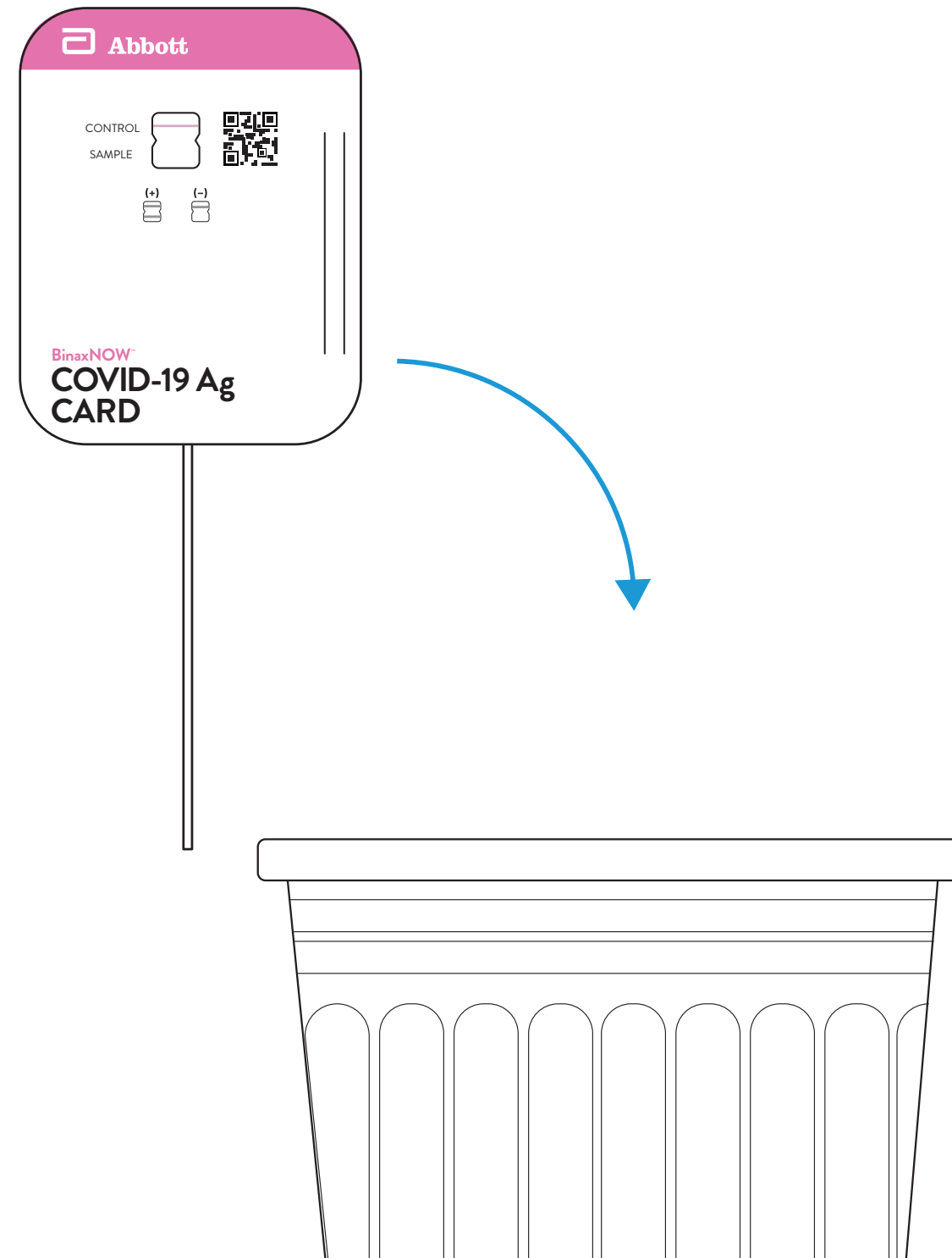

Reporting Patient Results Using NAVICA

Upon completion of the test and result interpretation, the telehealth proctor will send your test results via the NAVICA app. You will be notified by email and on your mobile device that your results are ready. You will go to the results screen in NAVICA to obtain your test results.

If your BinaxNOW COVID-19 Ag Card Home Test result is **Negative**, you will receive the following:

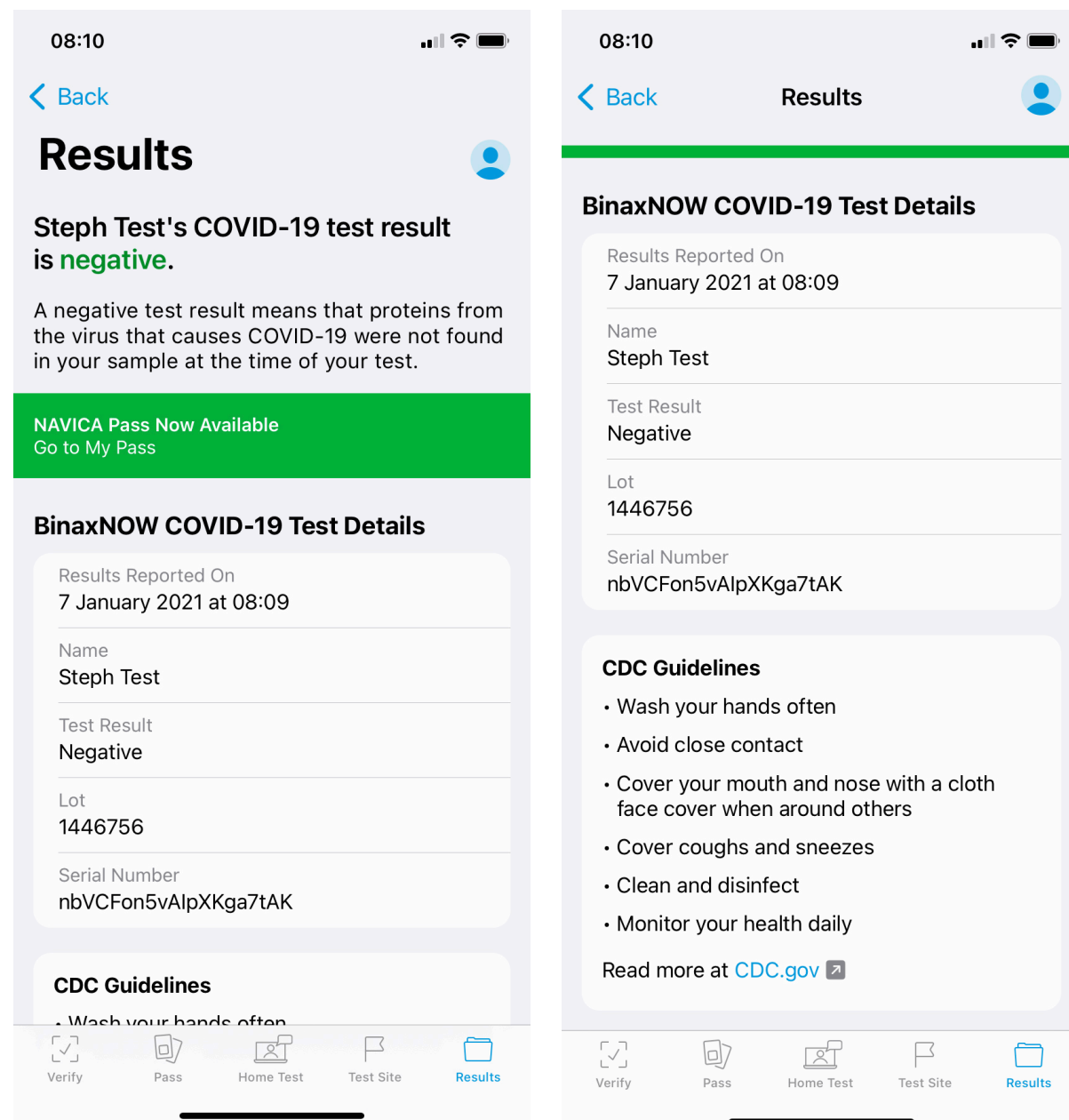

If your BinaxNOW COVID-19 Ag Card Home Test result is **Positive**, you will receive the following:

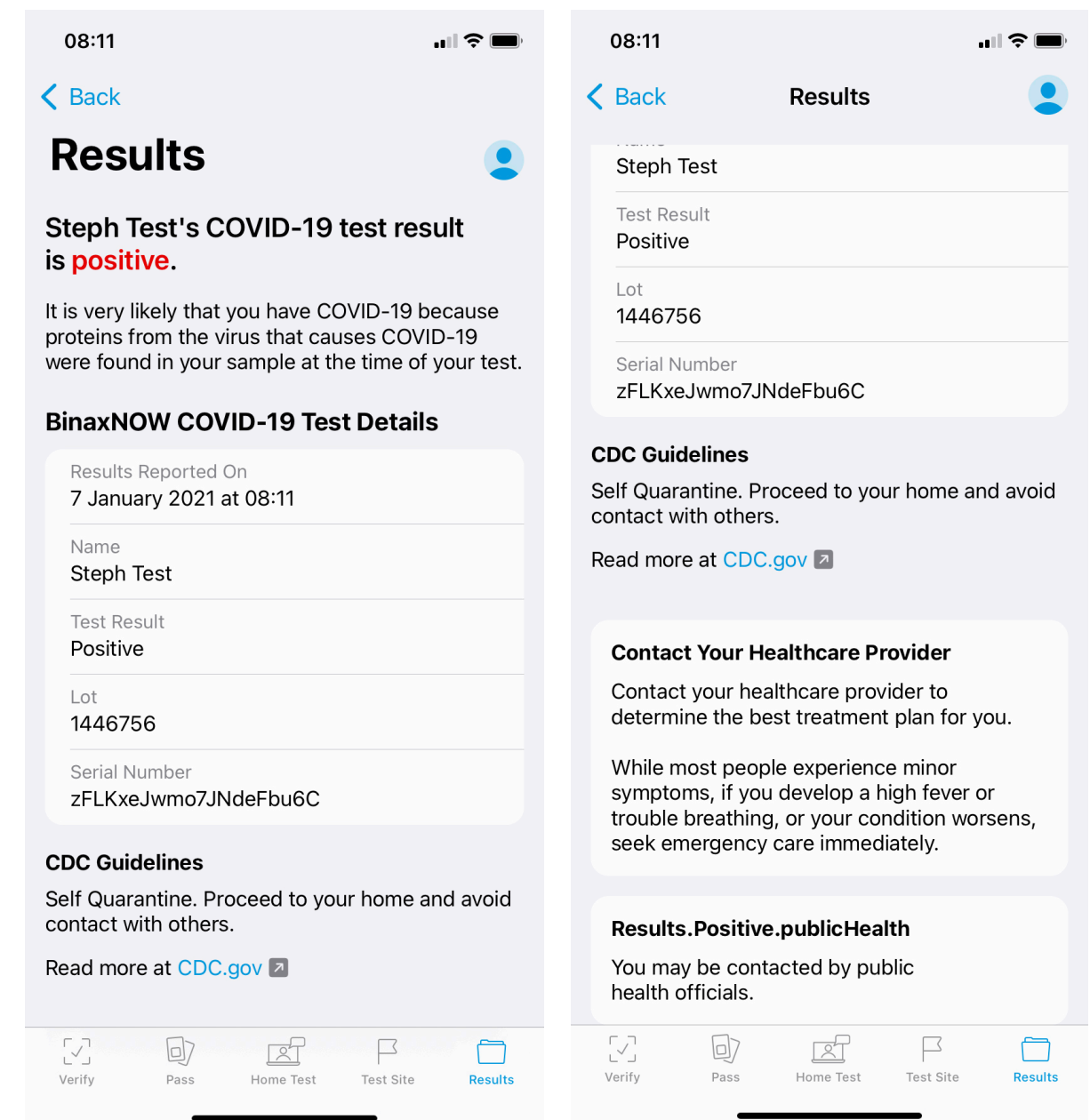

Reporting Patient Results Using NAVICA

Upon completion of the test and result interpretation, the telehealth proctor will send your test results via the NAVICA app. You will be notified by email and on your mobile device that your results are ready. You will go to the results screen in NAVICA to obtain your test results.

If the BinaxNOW COVID-19 Ag Card Home Test result is **Invalid**, you will receive the following:

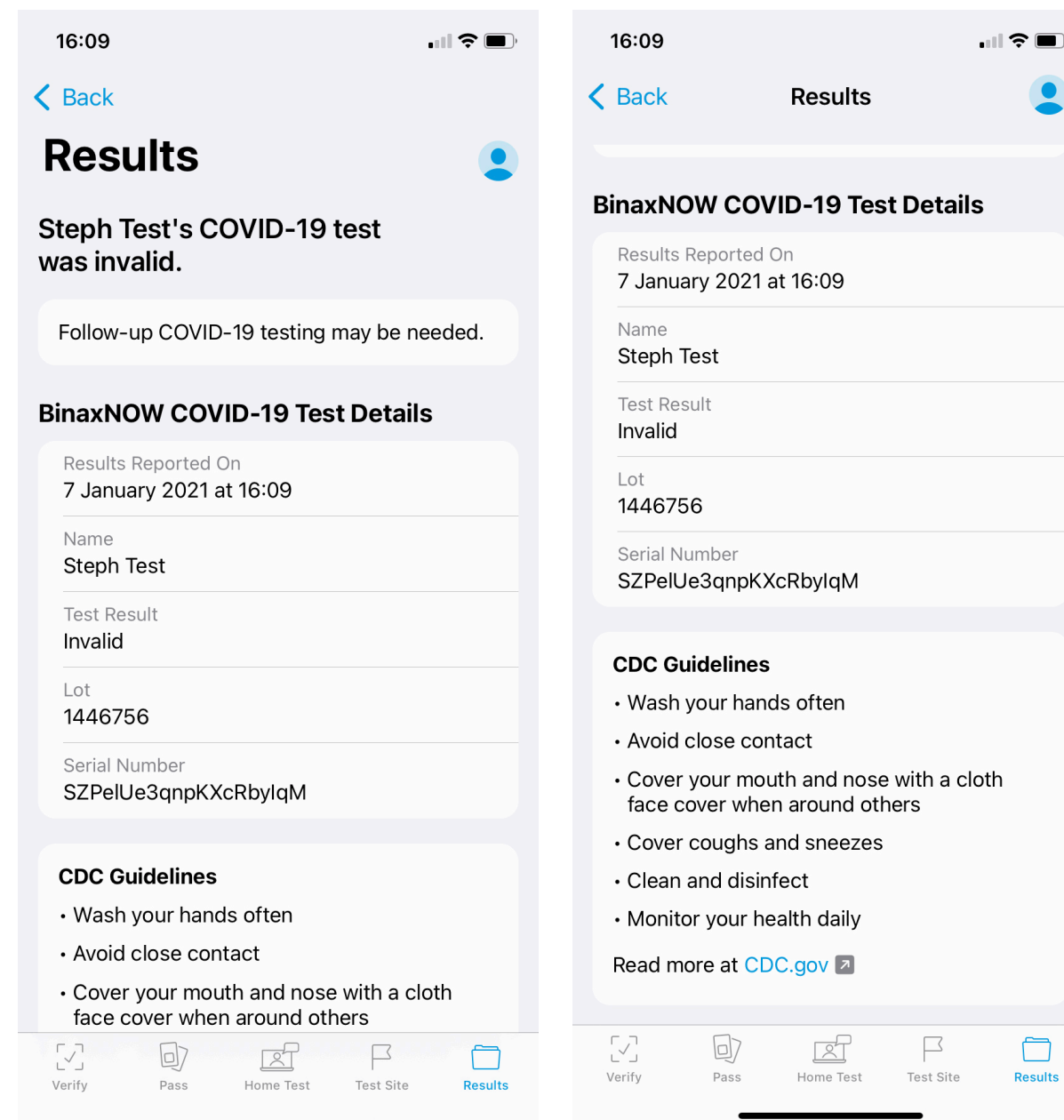

Abbott
BinaxNOW
COVID-19 Ag Card Home Test

Procedure Card

Size:
16.35 in. x 12.21 in.

Colors

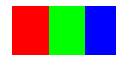

RGB

For Reference Only



PMS 2995 C
Primary Blue



PMS 303 C
Dark Blue



PMS 224 C
Magenta-Pink

PN: IN195101
Rev: 4

Date of Last Revision:
4.5 2021/03/28